

Slave 1 v2.0

Design and diagrams by Max d'Anger

Designed: 11/05/2016

Diagrammed: 12/05/2016

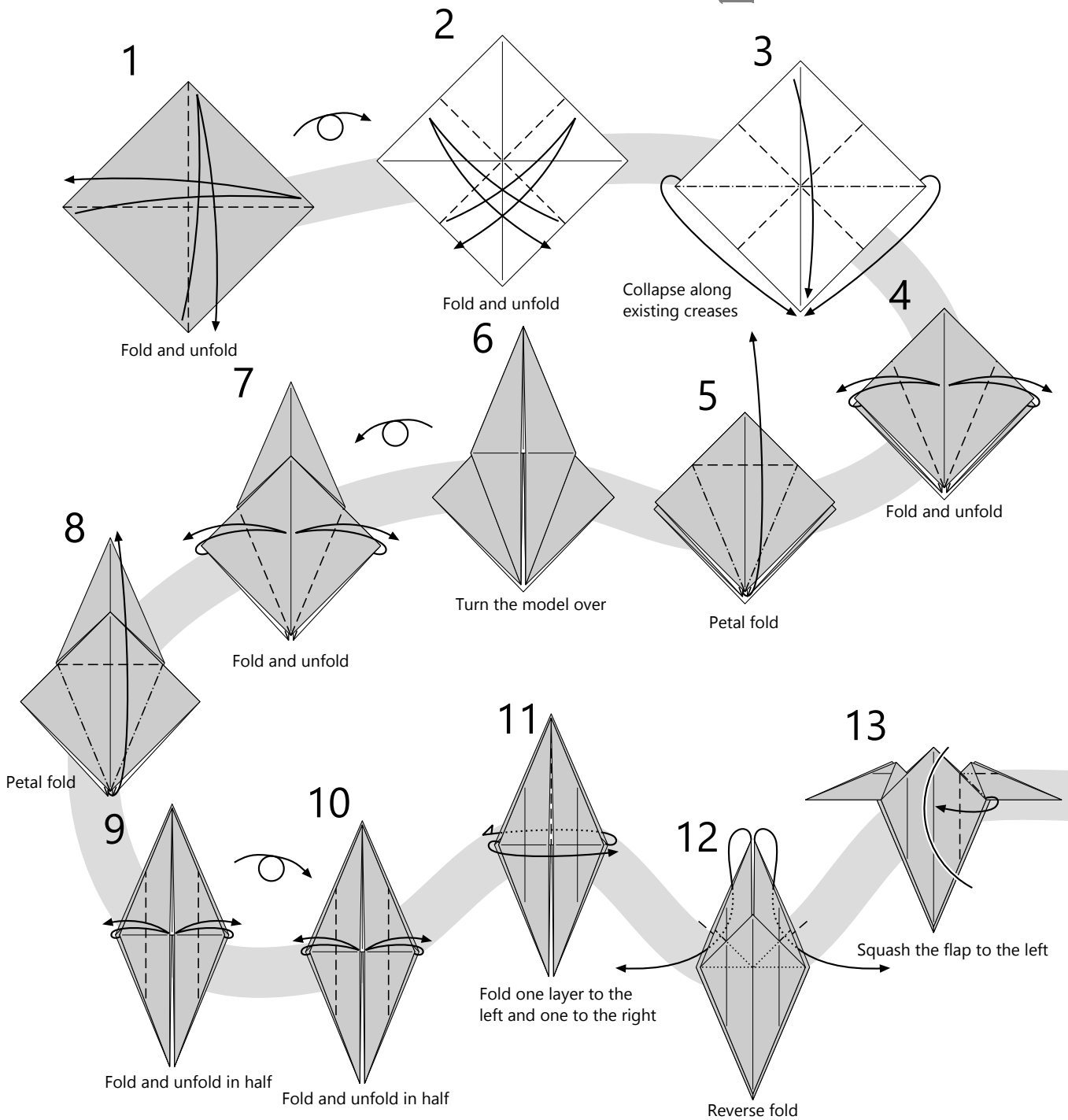
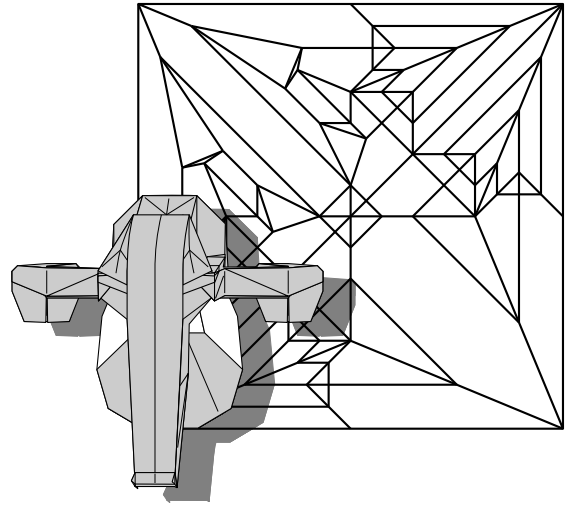

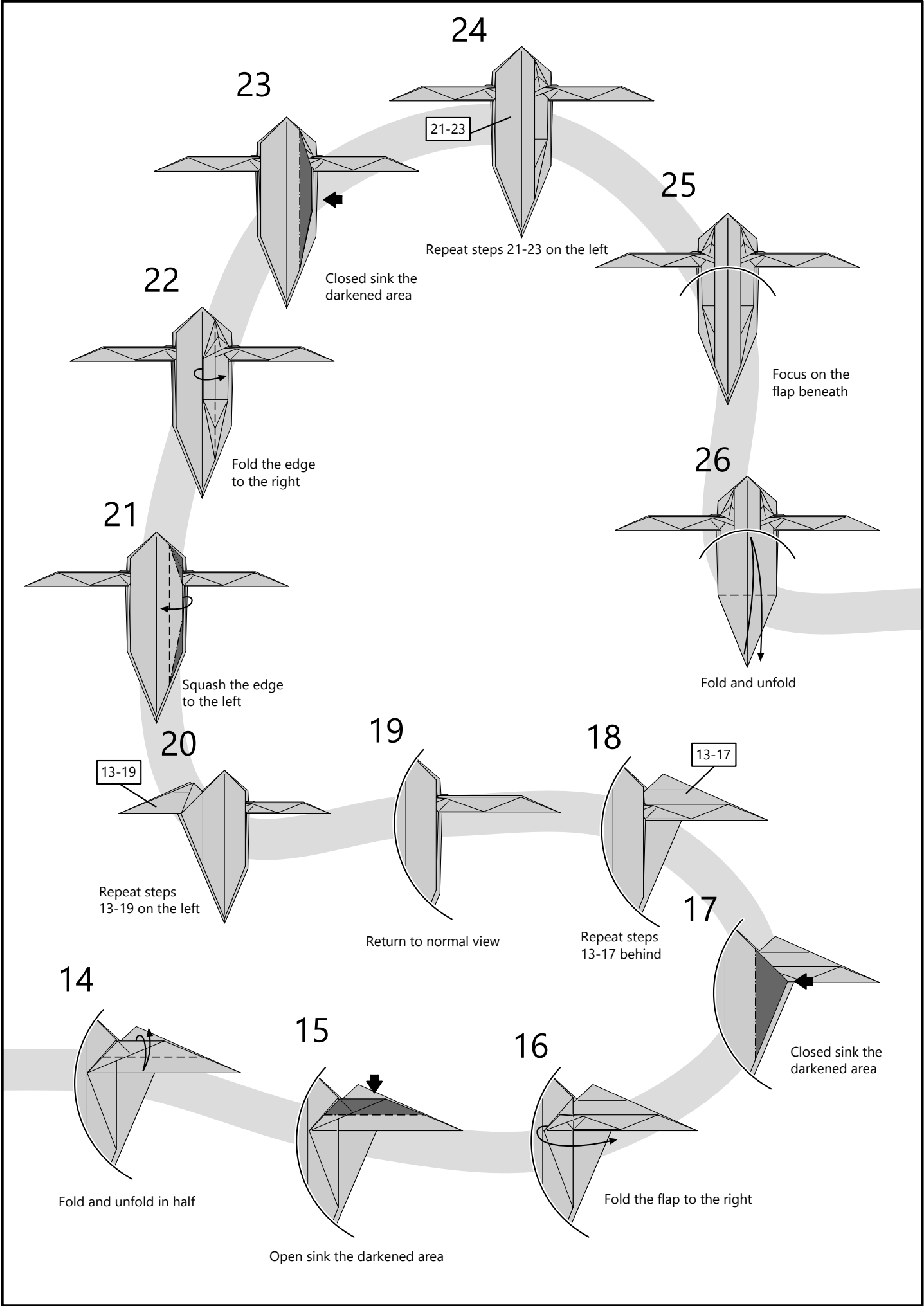

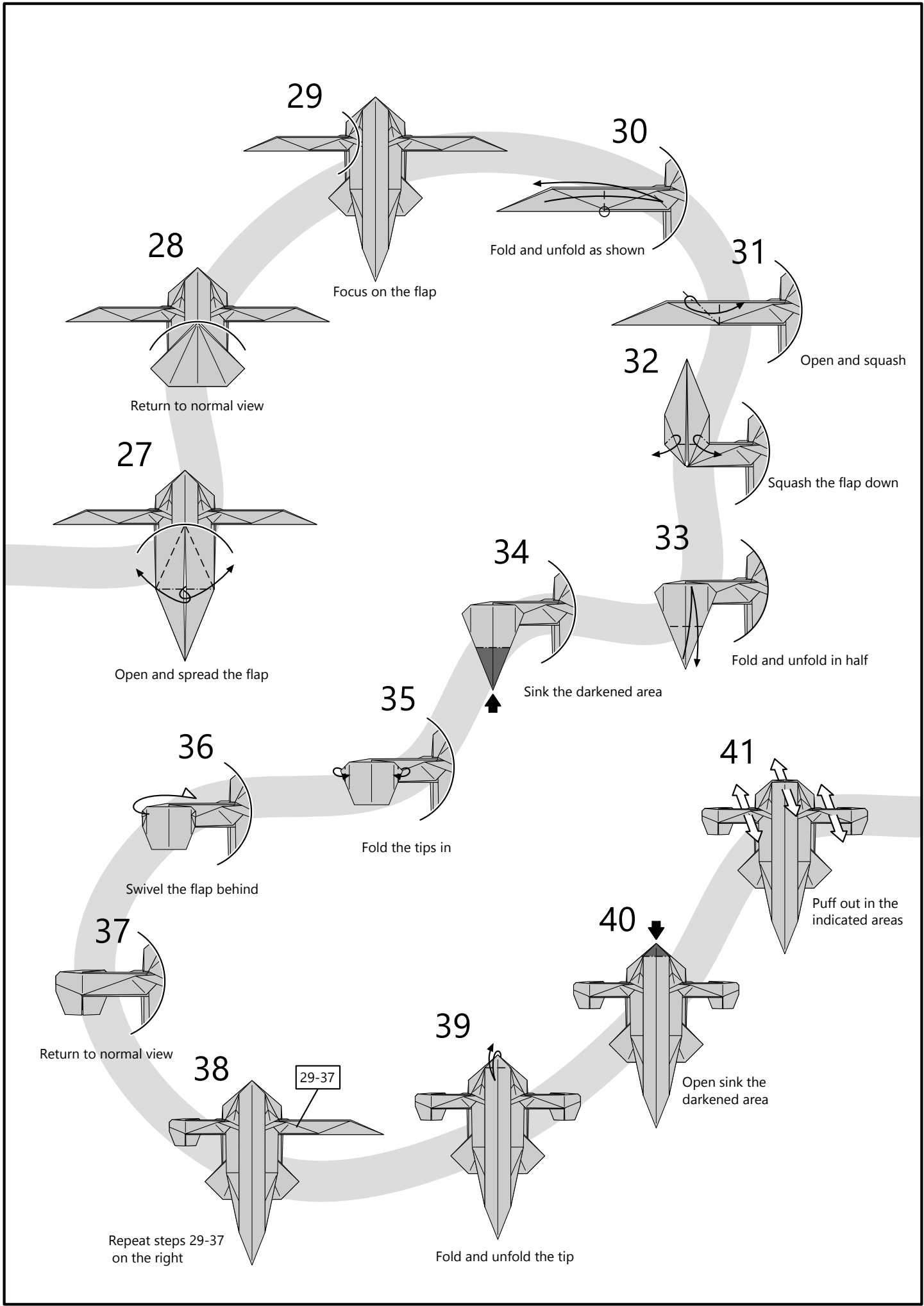

45

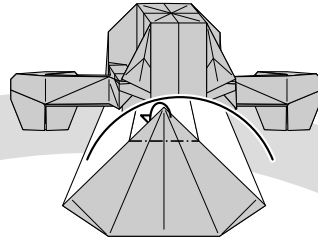

Mountain fold the tip

46

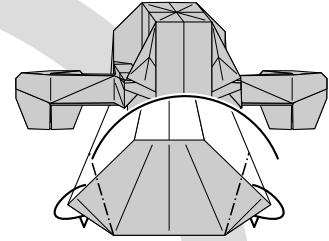

Fold the edges behind

44

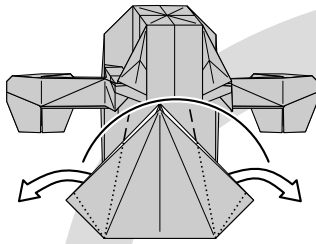

Swivel the edge

43

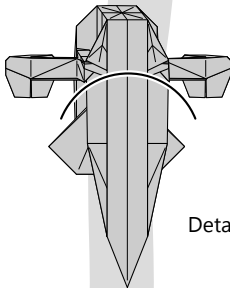

Detail on the flap beneath

47

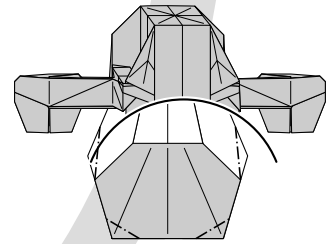

Fold the tips behind

42

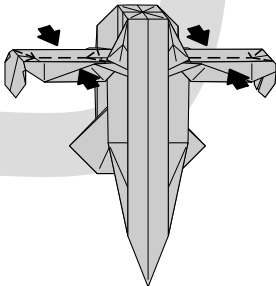

Pinch the flaps

48

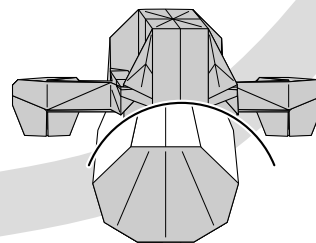

Return to normal view

49

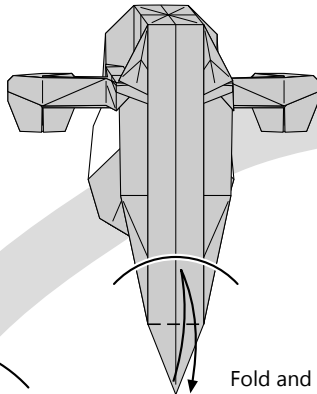

Fold and unfold

53

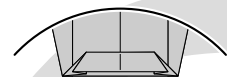

Return to normal view

50

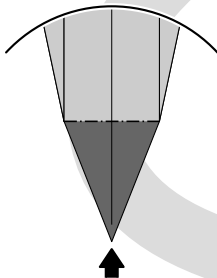

Open sink the darkened area

51

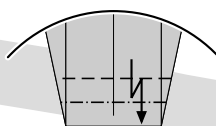

Crimp the edge

52

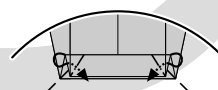

Reverse fold

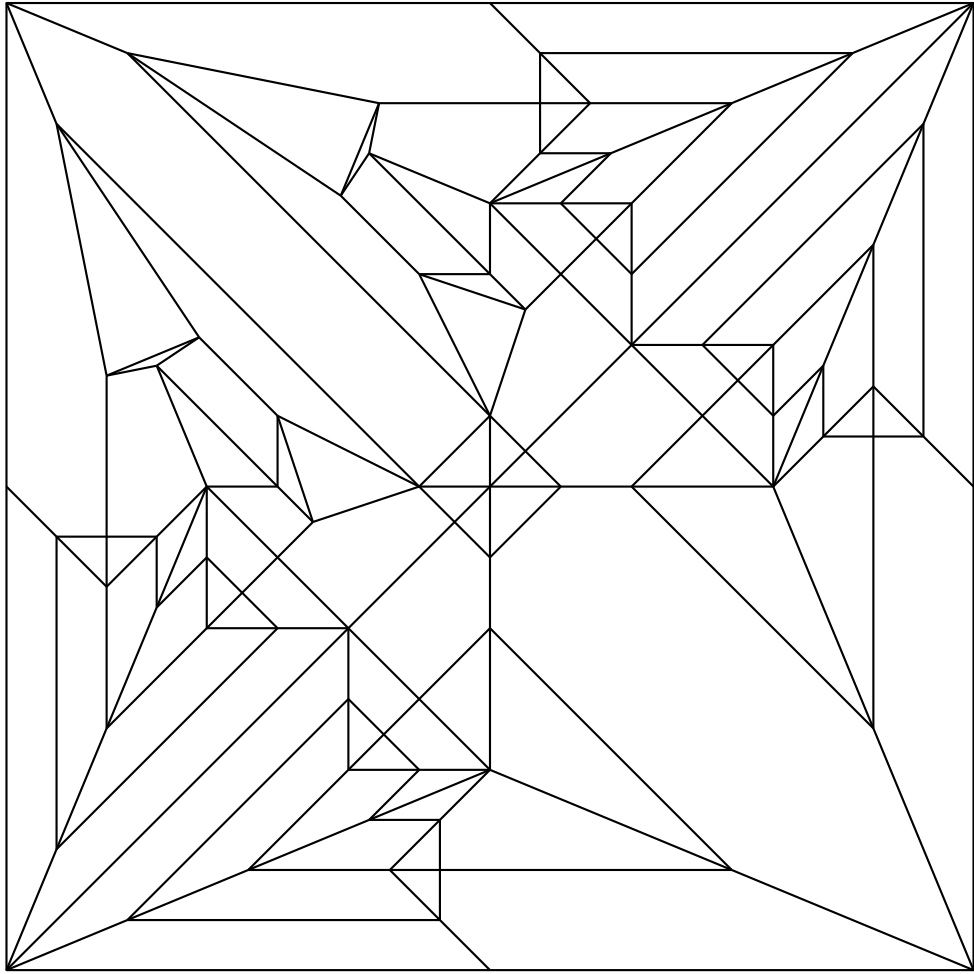

54

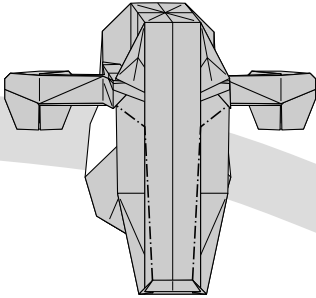

Shape the flap

55

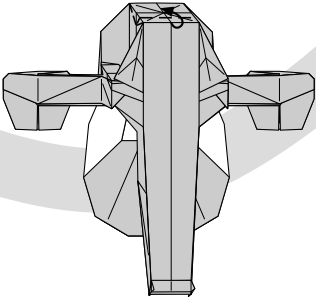

Crimp the tip and shape the model

56

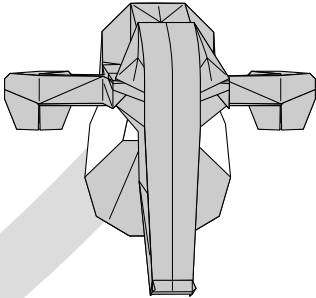

Finished